

info@involvo.com
www.involvo.com

INVOLVO

we wrap it. whatever. since 1971

Swiss quality. Swiss made. 

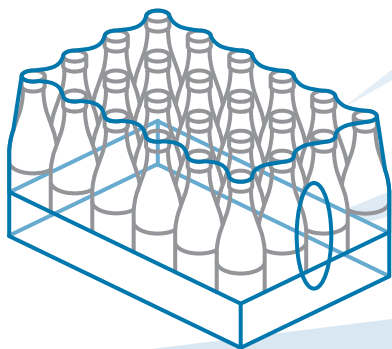
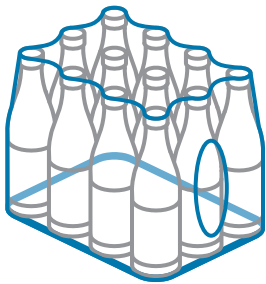
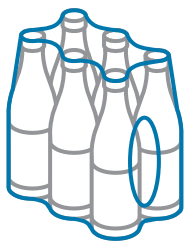

INVOSPEED

Continuous Motion High-Speed Shrink Wrapper



Intermittierende Bewegung Hoch-Geschwindigkeit Schrumpfverpackung

Fardelleuses hautes cadences en mode continu

Fardellatrice ad alta velocità a moto continuo

High speed Shrink Wrapper – INVOSPEED

Hoch-Geschwindigkeit Schrumpferpackung

Fardeleuse hautes cadences

Fardellatrice ad alta velocità

The INVOSPEED is a reliable, high-speed and intelligent shrink-wrapping machine, truly in an innovative class of its own. The machine is an almost wear free. It has easily accessible design with zero change parts, while the changeover remains short and simple for operators.

HIGHLIGHTS:

- Continuous motion single roll shrink wrapper
- Up to 100 cycles/min, servo technology
- Can handle single, dual or triple lane configuration
- Available in film only, pad+film or tray+film configuration
- Low maintenance costs
- No changeover parts needed
- Worldwide availability of our standard components



INVOSPEED

Output samples

Ausgabemuster
Emballages réalisables
Campioni di confezioni



Die INVOSPEED ist eine zuverlässige, Hochgeschwindigkeits- und intelligente Schrumpferpackung Maschine, die wirklich zur eigenen innovativen Klasse gehört. Die Maschine ist praktisch verschleißfrei und bietet eine leicht zugängliches Design mit null-Umstellung Teile. Die Invospeed ist für eine kurze Umstellung und Einfachheit für Betreiber entworfen.

INVOSPEED est une fardeleuse hautes cadences, performante et fiable, et réellement innovante dans sa catégorie. Cette machine a un taux d'usure pratiquement inexistant. Sa conception et son design en font une machine simple et accessible, sans pièce à changer lors des changements de formats, simples et rapides pour les opérateurs.

INVOSPEED è una fardellatrice intelligente ad alta velocità , affidabile, veramente innovativa nella sua categoria. La macchina è praticamente esente da usura . Ha un design semplice ed accessibile con nessuna parte rimovibile a formato, mentre il cambio formato rimane semplice e rapido per gli operatori.



HIGHLIGHTS:

- Kontinuierliche Bewegung einzigen Rolle Schrumpfverpackung
- Bis zu 100 Zyklen / min, Servotechnik
- Kann single-, dual-oder dreifach-Spur-Konfiguration handhaben
- Verfügbar in Film nur, pad + Film oder Tablett + Film-Konfiguration
- Niedrige Wartungskosten
- Keine Umstellung Teile sind benötigt
- Weltweite Verfügbarkeit unserer Standard-Komponenten

CARACTERISTIQUES:

- Fardeleuse à mouvement continu
- Jusqu'à 100 cycles/minute, technologie servo
- Peut travailler des configurations en simple, double ou triple piste.
- Disponible dans des configurations film seul, plaque + film ou barquette + film
- Coûts de maintenance réduits
- Aucune pièce nécessaire lors des changements de formats
- Composants standards disponibles dans le monde entier

CARATTERISTICHE:

- Fardellatrice con singolo rullo a moto continuo
- Fino a 100 cicli al minute , tecnologia servo
- Può lavorare configurazioni di linea singole, doppie o triple.
- Disponibile in configurazione solo con film , falda + film o vassoio + film
- Bassi costi di manutenzione
- Non è richiesta nessuna parte per il cambio formato
- Componenti standard disponibili in tutto il mondo

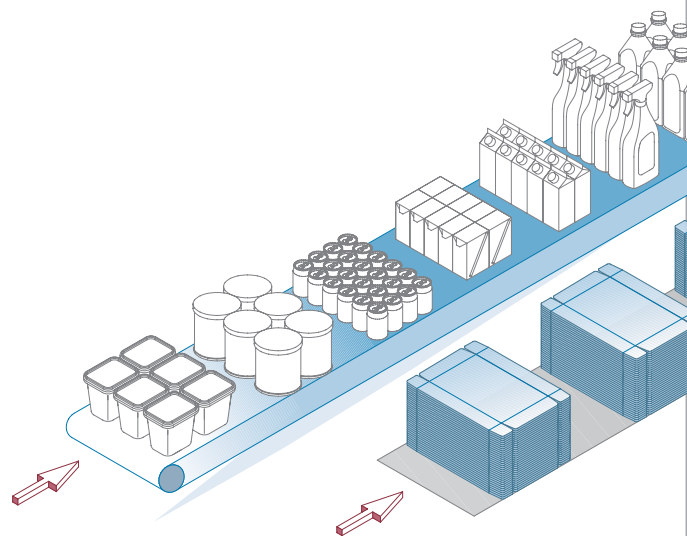

INVOLVO

we wrap it. whatever. since 1971

Swiss quality. Swiss made. 

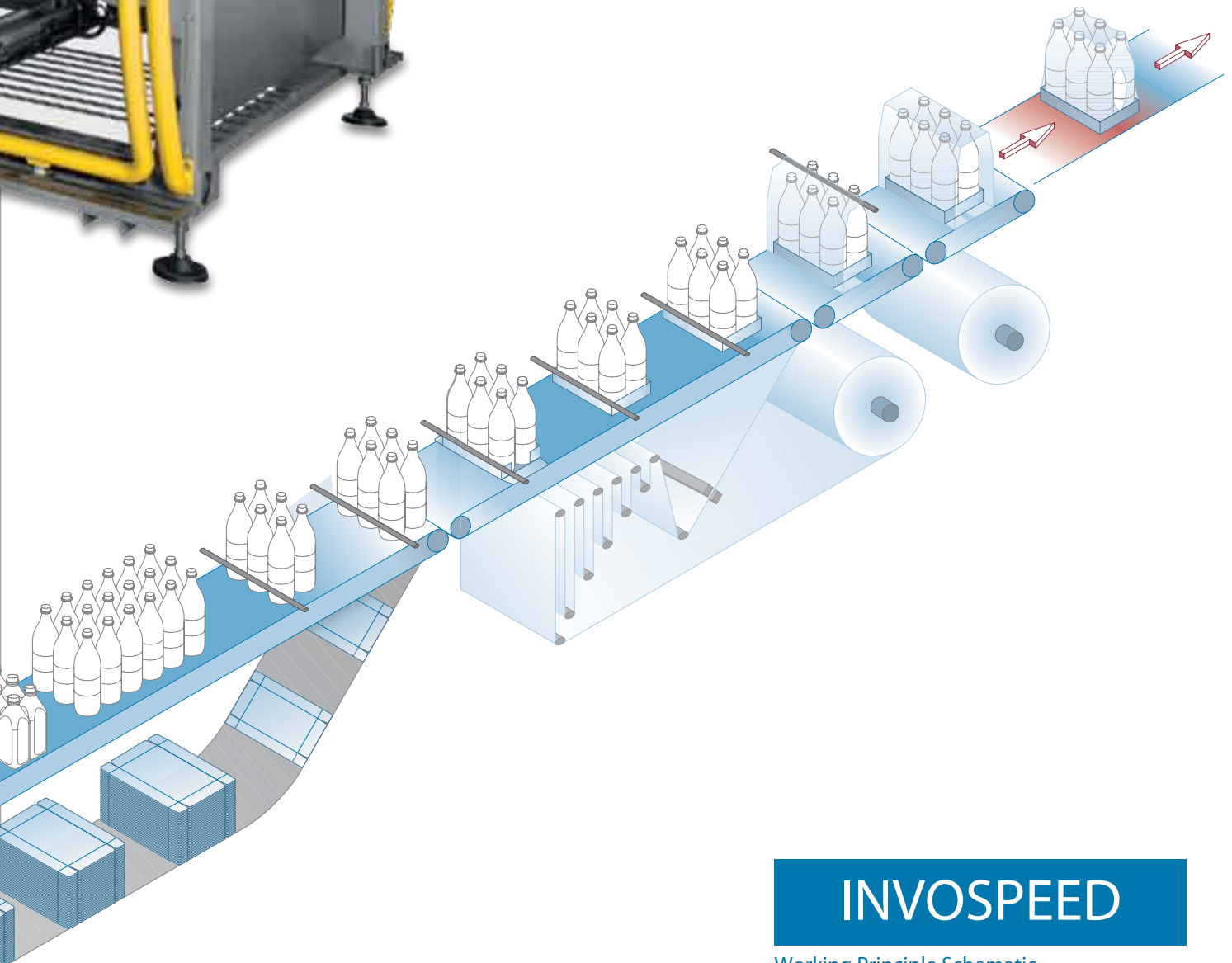

INVOSPEED

Working Principle Schematic

Arbeitsprinzip Schaltbild
Cycles de fonctionnement
Ciclo di funzionamento



1

Lane Divider

Spur Trenneinrichtung
Diviseur / séparateur
Divider a file



3

Automatic Blank magazine

Automatische Zuschnittmagazin
Magasin automatique de découpes
Magazzino cartoni automatico



2

Grouping Section

Gruppierstation
Zone de préformation des produits
Preformazione prodotto

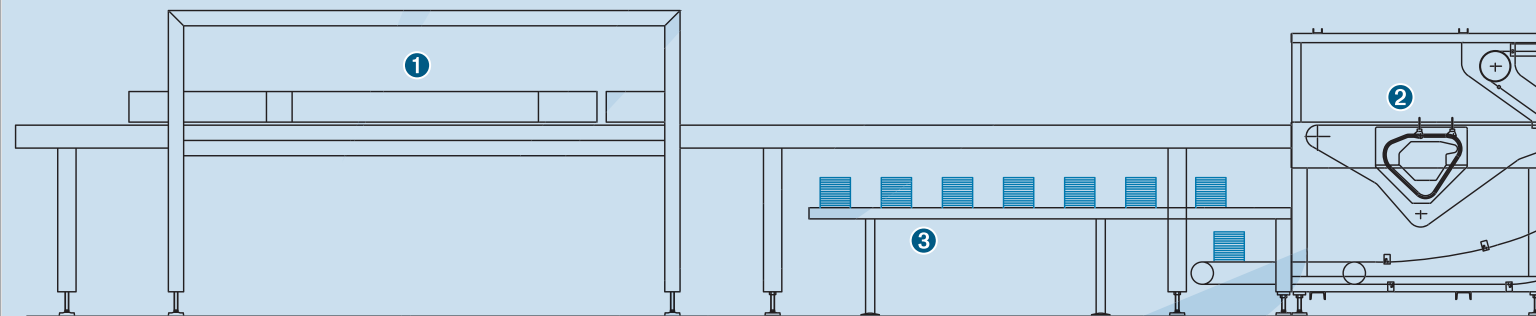

4

Product Spacing and Synchronization

Produkt Abstand und Synchronisierung
Synchronisation et espacement des produits
Sincronizzazione e spaziatura prodotto



5

Shrink Film Applicator

Schrumpffolie Applikator
Application du film thermorétractable
Applicatore film termoretraibile



6

Shrink Tunnel

Schrumpftunnel
Tunnel de rétraction pour film thermorétractable
Forno per film termoretraibile



90 degree infeed for shaped bottles

90 Grad Einspeisung für Formflaschen

Entrée à 90° pour les bouteilles de forme

Ingresso a 90° per bottiglie sagomate

Infeed for cylindrical bottles

Einspeisung für zylindrische Flaschen

Entrée pour les bouteilles cylindriques

Ingresso per bottiglie cilindriche



Pick & Place infeed for shaped bottles

Pick & Place Einspeisung für Formflaschen

Entrée Pick & Place pour les bouteilles de forme

Ingresso Pick & Place per bottiglie sagomate

Pad/Tray unit

Pad / Tablett-Einheit

Module plaque/barquette

Unità falda/vassoio

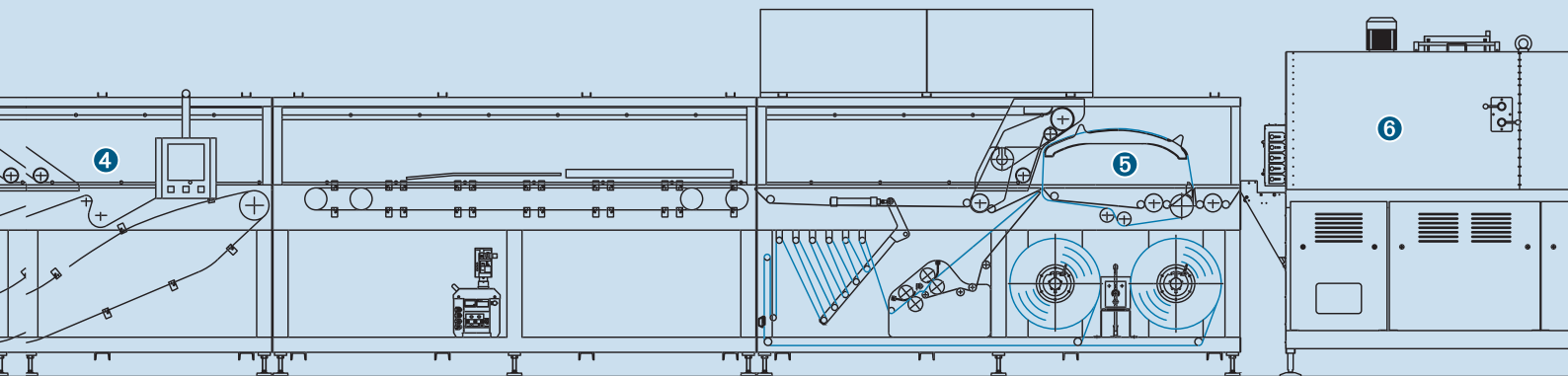

End of Line Automation. Involve in action.

INVOLVO is one of the pioneers and a leader for over 40 years in wrap around case packing and high speed shrink wrapping technology, servicing various industries, particularly Food & Beverages, Dairy, Personal & Home care sectors.

INVOLVO ist einer der Pionieren und Marktführer seit über 40 Jahren in Wraparound Kartonverpackung und Hochgeschwindigkeit Schrumpferpackung Technologie und bedient verschiedene Industrien, vor allem Nahrungs- und Genussmittelindustrie, Milchindustrie, Haushalts- und Körperpflege-Industrie.

INVOLVO se positionne comme l'un des pionniers de l'encaissage Wrap around et du fardelage à hautes vitesses. Involve reste un des leader dans l'encaissage, au service de nombreux industriels depuis plus de 40 ans, particulièrement dans les domaines de l'agroalimentaire (boisson, food, produits laitiers), de la chimie (produits d'entretien et détergents) et de la cosmétique.

INVOLVO è tra i pionieri di incartonatrici Wrap around & fardellatrici ad alta velocità. Involve è il leader dell'incartonamento, da oltre 40 anni al servizio di varie industrie, particolarmente per food e bevande, lattiero caseario, prodotti per la casa e per l'igiene.

INVOLVO
we wrap it. whatever. since 1971

Swiss quality. Swiss made. 

Involve Wrapping Solutions AG

Mühleweg 3

CH-5524 Niederwil AG

Switzerland

Tel. +41 56 678 88 88

Fax +41 56 678 88 00